

DISPLAYS

Design Guide

8th Edition

July 2009

Industry's most comprehensive portfolio of LED/LCD display solutions



Inside

Page

Portable display backlighting with integrated ESD protection	2
Highly flexible I ² C port expanders	3
8x8 keypad controller with integrated ESD protection	4
Touch-screen and tactile-feedback controllers	5, 6
LVDS-interfaced LED driver for video walls	7
Constant-current LED drivers with fail-safe features	8
Products for LED, LCD, and VFD displays	9
Programmable spread-spectrum, 27-bit SerDes for navigational systems	10
Programmable gamma reference generators and VCOM calibrators	11
High-brightness LED drivers for display backlighting	12-15



Single-chip backlighting solution with GPIOs and integrated ESD protection

The MAX6948* is a single-chip backlighting solution for cell phones. This device incorporates a boost converter and high-current drivers for up to three display backlights, plus three additional GPIO ports for indicators and switches. All ports feature 10-bit PWM intensity control. The boost converter integrates an LX switch to reduce external part count, and is capable of providing up to 28V at a load current of 30mA. The MAX6948 utilizes a 2MHz switching rate to minimize the size of the external inductor.

- **Integrated ESD protection on all ports**
 - $\pm 8\text{kV}$ HBM (Human Body Model)
 - $\pm 15\text{kV}$ IEC 61000-4-2 Air-Gap Discharge
- **External enable input for the LCD backlight step-up converter**
- **Configurable power-up control of external circuits**
- **AD0 pin to select one of four available slave IDs**
- **Dedicated reset input for the I²C serial interface**
- **Smallest device in its class: 2.3mm x 2.3mm, 25-bump WLP**

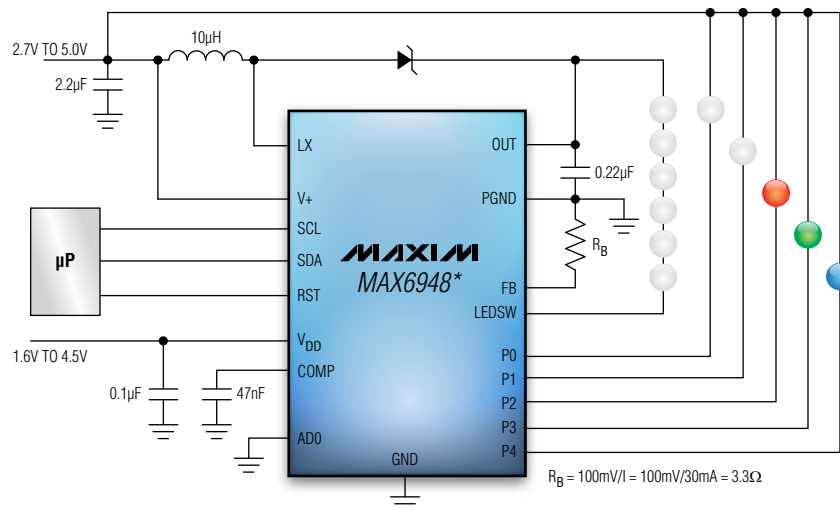
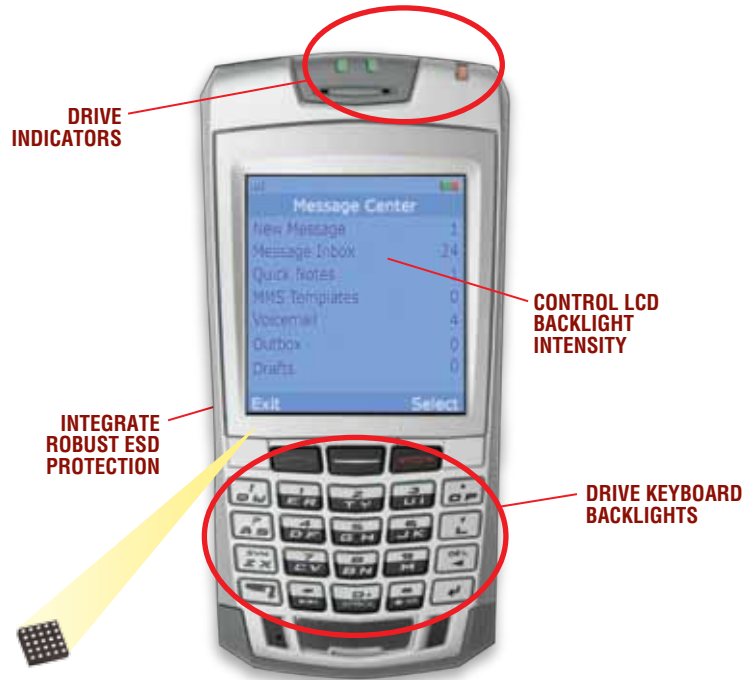

*Future product—contact the factory for availability.

Industry's lowest power port expanders and LED drivers

Drive LEDs from low-voltage buses in portable applications

The industry's lowest power LED drivers, the MAX7302 and MAX7306/MAX7307 are ideal for interfacing with low-voltage processor I/Os. These highly flexible devices provide nine GPIOs (MAX7302) or four GPIOs (MAX7306/MAX7307) that can be configured as open-drain or push-pull outputs, as logic inputs with transition detection and optional debounce, or as outputs that can sink 25mA to drive LEDs. Additionally, an integrated oscillator gives users complete control over the intensity and blinking rate of each LED.

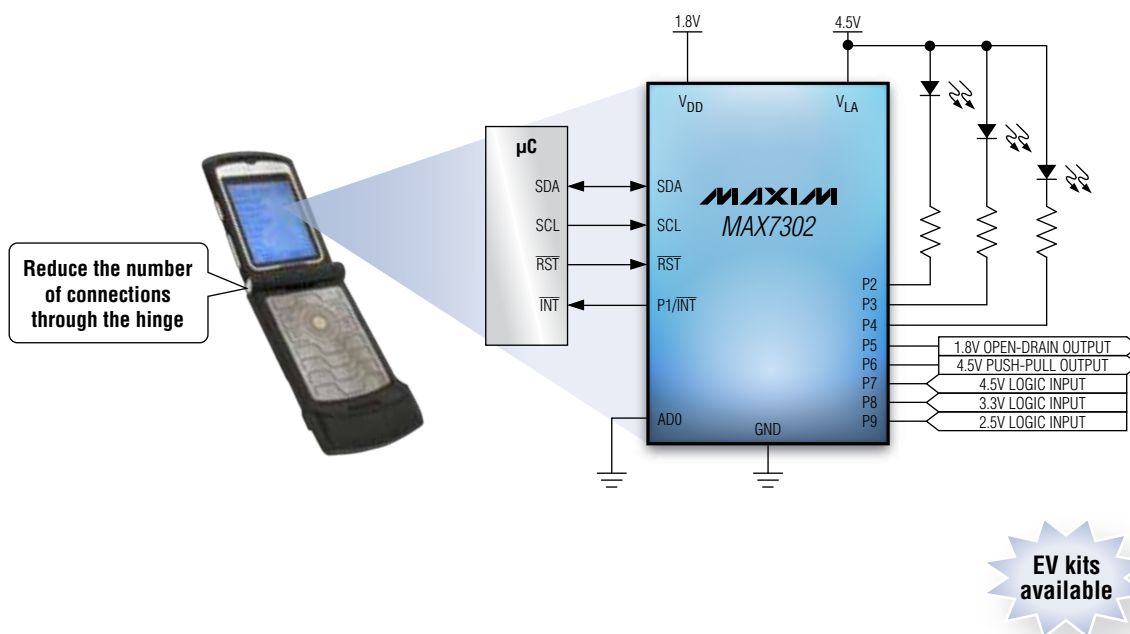

Part	Ports	Interface Type	Supply-Voltage Range (V)	Sink Current (mA per Pin)	Standby Current (μA at $+125^\circ\text{C}$)	Features
MAX7302	9	I ² C	1.62 to 3.6	25	2.0	4 slave IDs, PWM, blink, RST
MAX7306/07	4	I ² C	1.62 to 3.6	25	2.0	4 slave IDs, PWM, blink, RST
MAX7319–23	8	I ² C	1.71 to 5.5	20	1.9	16 slave IDs
MAX7324–27	16	I ² C	1.71 to 5.5	20	1.9	16 slave IDs
MAX6966/67	10	SPI™	2.25 to 3.6	20	1.9	1.5% constant current, PWM
MAX6946/47	10	I ² C	2.25 to 3.6	20	1.5	1.5% constant current, PWM
MAX7315	8	I ² C	2 to 3.6	50	3.3	64 slave IDs, PWM
MAX7316	10	I ² C	2 to 3.6	50	3.3	64 slave IDs, PWM, RST, INT
MAX7313	16	I ² C	2 to 3.6	50	3.6	64 slave IDs, PWM
MAX6964	18	I ² C	2 to 3.6	50	3.3	4 slave IDs, PWM, blink
MAX7310	8	I ² C	2.3 to 5.5	30	3.9	56 slave IDs, bus timeout
MAX7300/01	20/28	I ² C/SPI	2.5 to 5.5	10	11	16 slave IDs

For our complete portfolio of GPIO port expanders, visit:
www.maxim-ic.com/GPIO

SPI is a trademark of Motorola, Inc.

8x8 keypad controller with 8 GPIOs/LED drivers integrates advanced ESD protection

The MAX7360 is a key-switch controller featuring multiple key-press/release detection and enhanced ESD protection. It includes eight GPIOs/LED drivers that can be used for keypad backlighting, driving LED indicators, and port expansion. Integrated ESD protection saves space and avoids the cost of external protection components. Providing a complete solution for keyboard control and backlighting, the MAX7360 is ideal for smartphones, cell phones, pocket PCs, and other portable consumer-electronics applications.

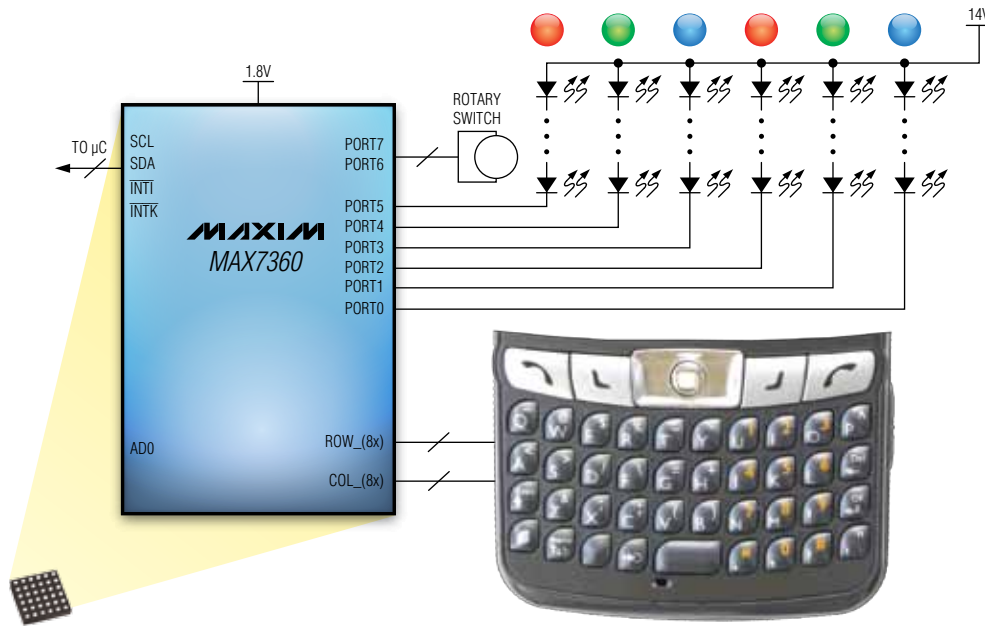

- **Integrated ESD protection: ±8kV Contact, ±15kV Air-Gap Discharge (IEC 61000-4-2)**
- **Keyscan uses static matrix monitoring for low EMI**
- **Individual LED blink rates and PWM intensity control on GPIO ports**
- **Drives rotary switch directly**

Part	Keys Monitored	I/Os	Supply-Voltage Range (V)	ESD Protection	Package
MAX7359	Up to 64	Up to 7 GPIOs	1.62 to 3.6	±2kV HBM	24-TQFN
MAX7360	Up to 64	8, up to 7 GPIOs	1.62 to 3.6	±8kV Contact, ±15kV Air-Gap Discharge	40-TQFN, 36-WLP

Industry's smallest and smartest touch-screen controllers

The MAX11800* (SPI) and MAX11801* (I²C) are resistive touch-screen controllers (R-TSCs) available in TQFN and ultra-small WLP packages. These devices have advanced operating modes and other digital functionality to reduce bus loading of the system/applications processor, minimize power consumption, avoid system latency, and simplify host-processor interpretation of complex touch patterns (gesture recognition). Targeted applications include MIDs, netbooks, and UMPCs; mobile phones; MP3 players; PNDs; game consoles; and POS terminals.

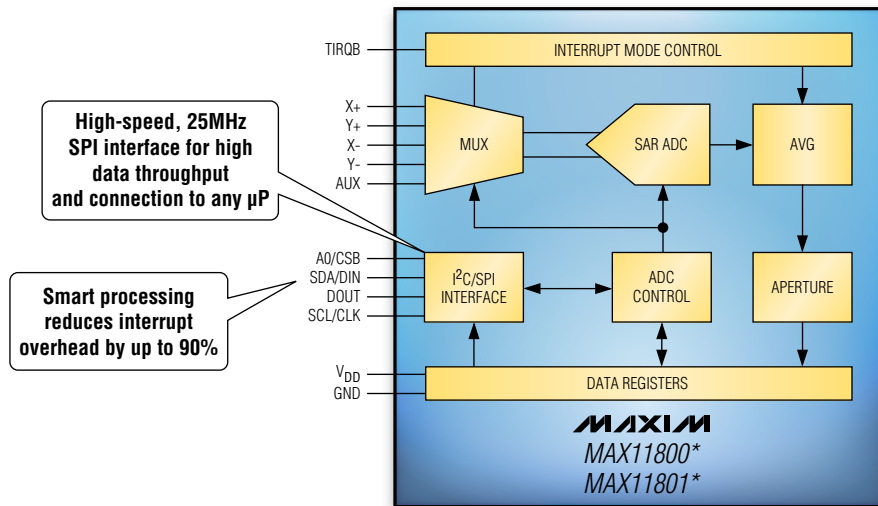

High-speed, 25MHz SPI interface for high data throughput and connection to any μ P

Smart processing reduces interrupt overhead by up to 90%

Complete R-TSC reduces PCB footprint by 62%



Only 1.6mm x 2.1mm!

- Digital preprocessing reduces bus loading and host processor resources
- Advanced operating modes decrease processor servicing and overhead
- Advanced programmability allows both pressure and coordinate measurement
- Automatic power-down saves power—ideal for low-power applications
- Programmable scan rate enables tradeoff between power and accuracy

- Advanced filtering improves touch accuracy
- Programmable aperture eliminates unnecessary interrupt generation
- Space-saving WLP and TQFN packages aid miniaturization of end products
- I²C (400kHz) and SPI (25MHz) part versions allow connection to any host μ P
- High-speed, 25MHz SPI interface provides high data throughput

*Future product—contact the factory for availability.

Comprehensive tactile-feedback solutions save space in portable devices

The MAX11810* (SPI) and MAX11811* (I²C) are innovative R-TSCs with integrated tactile-feedback drivers for ERM and LRA motors. These devices also contain the drive and sense circuits required to implement a proximity detector. They can directly connect to the motor to create tactile feedback, thereby eliminating the need for a dedicated interface on the application processor or system microcontroller. Moreover, these R-TSCs implement all features of the MAX11800*/MAX11801* to reduce bus loading, save processor power, and simplify the implementation of gesture recognition.

Fully integrated touch-screen controllers

- Support tactile-feedback generation
- On-chip drive and sense circuits ease implementation of proximity detection

Flexibility

- Drive a DC motor directly
- Drive piezo actuators when used in combination with a tactile piezo controller

Low-power operation for power-sensitive applications

- On-chip data preprocessing reduces load on application processor
- Automatic power-down and wake-up upon touch detection

Application diagram

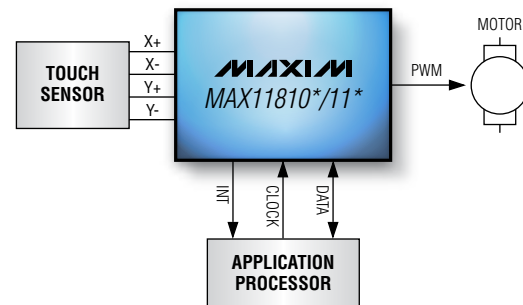

Part	Resolution (Bits)	Tactile Feedback	Proximity Sensing	Keypad Decoder	Interface	Power Supply (V)	Package	Price† (\$)
MAX11800*	12/8				SPI	1.7 to 3.6	12-TQFN, 12-WLP	1.51
MAX11801*	12/8				I ² C	1.7 to 3.6	12-TQFN, 12-WLP	1.46
MAX11802*	12/8				SPI	1.7 to 3.6	12-TQFN, 12-WLP	1.20
MAX11803*	12/8				I ² C	1.7 to 3.6	12-TQFN, 12-WLP	1.16
MAX11810*	12/8	✓	✓		SPI	1.7 to 3.6	20-TQFN, 16-WLP	1.75
MAX11811*	12/8	✓	✓		I ² C	1.7 to 3.6	20-TQFN, 16-WLP	1.65
MXB7843	12/8				SPI/QSPI™	2.3 to 5.2	16-QSOP, 16-TSSOP	1.61
MXB7846	12/8				SPI/QSPI	2.3 to 3.75	16-QSOP, 16-TSSOP	1.70
MAX1233	12/10/8			✓	SPI/QSPI/MICROWIRE™	2.7 to 3.6	28-TQFN, 28-QFN	2.31
MAX1234	12/10/8			✓	SPI/QSPI/MICROWIRE	4.75 to 5.25	28-TQFN, 28-QFN	2.31

QSPI is a trademark of Motorola, Inc.

MICROWIRE is a trademark of National Semiconductor Corp.

*Future product—contact the factory for availability.

†1000-up recommended resale. Prices provided are for design guidance and are FOB USA. International prices will differ due to local duties, taxes, and exchange rates. Not all packages are offered in 1k increments, and some may require minimum order quantities.

EZCascade™ technology simplifies video-display design

Maxim's EZCascade technology employs an LVDS interface to enable thousands of LED drivers to be cascaded over long distances. This approach cuts the cost of large displays by reducing the need for multiple expensive processors; it also minimizes software overhead, thus simplifying display designs.

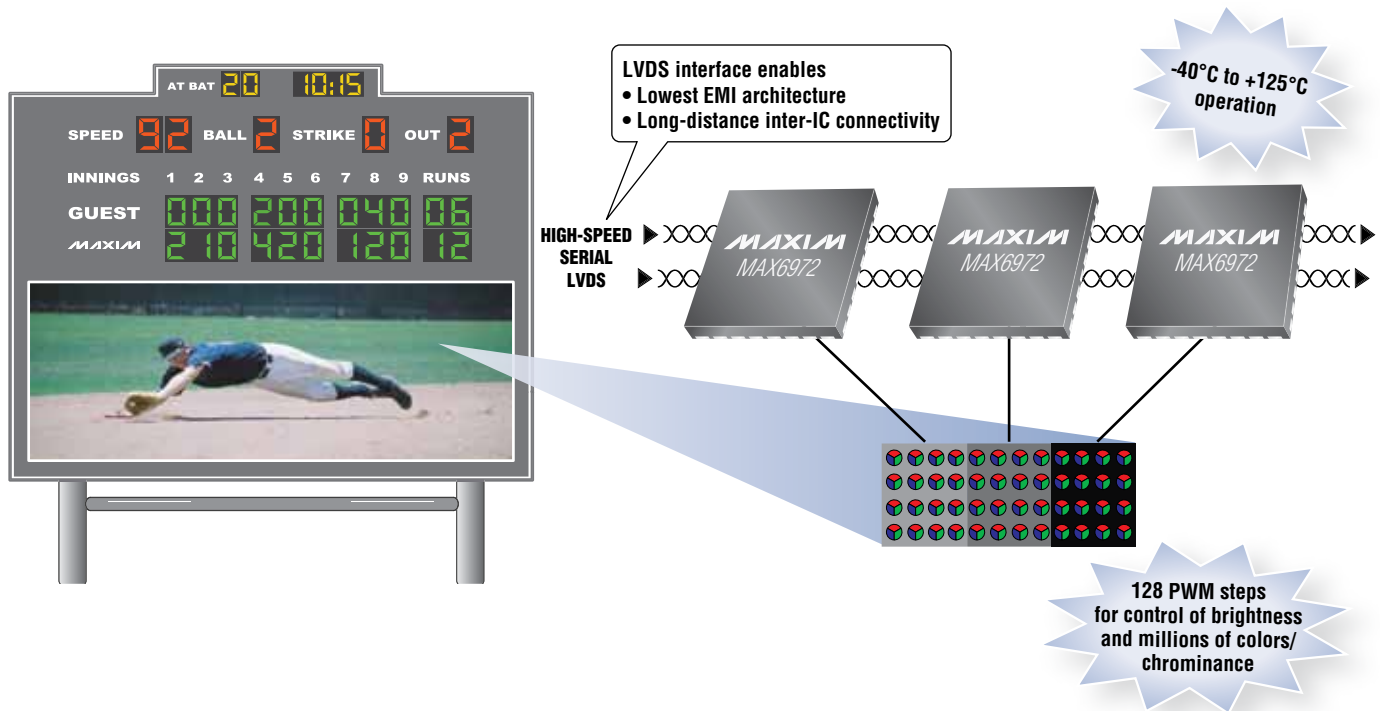

- Daisy-chained LVDS interface between the drivers
- 12/14 bits of individual PWM intensity control; 7/5 bits of global PWM intensity control
- ±1% port-to-port current-matching accuracy
- 24 ports on each driver to control 8 RGB pixels

Part	Outputs	Programmable Current Range (mA)	PWM Bits (Global)	PWM Bits (Individual)	Package
MAX6972	16	11 to 55	7	12	32-TQFN
MAX6973	16	11 to 55	5	14	32-TQFN
MAX6974	24	6 to 30	7	12	40-TQFN
MAX6975	24	6 to 30	5	14	40-TQFN

Complete evaluation kit is easy to employ for new design prototype builds:
www.maxim-ic.com/MAX6972EVkit

EZCascade is a trademark of Maxim Integrated Products, Inc.

8-/16-port constant-current LED drivers feature optional open-LED fault detection and watchdog

All use industry-standard pinouts for industrial lighting, signage, and transportation applications

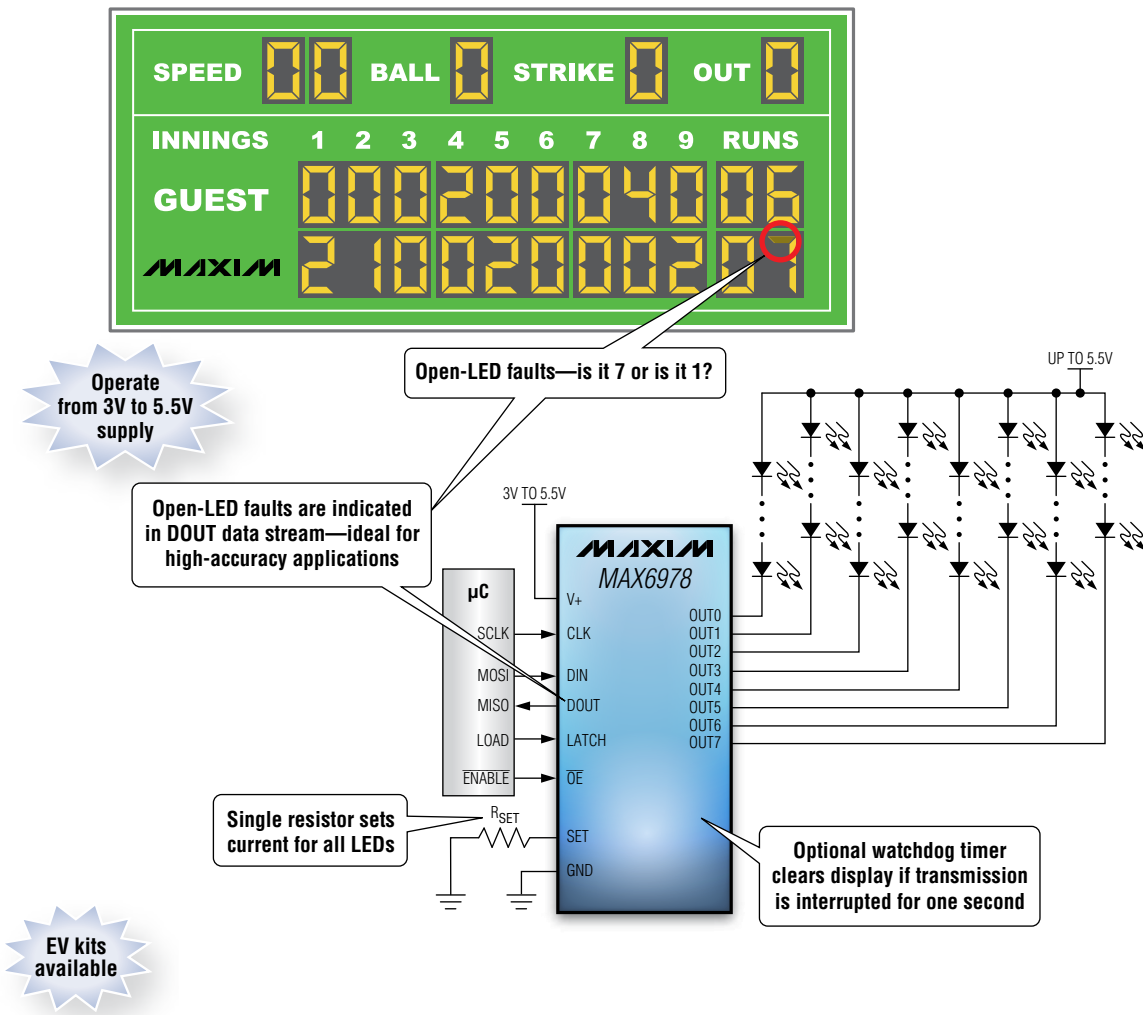

Part	Outputs	Output Voltage (V, max)	Output Current (mA, max)	LED Fault Detection	Watchdog	Temp Range (°C)
MAX6968	8	5.5	55			-40 to +125
MAX6977				✓		
MAX6978				✓	✓	
MAX6970		36				
MAX6969	16	5.5				
MAX6979			✓	✓		
MAX6971		36				

Most comprehensive selection of products for LED, LCD, and VFD displays

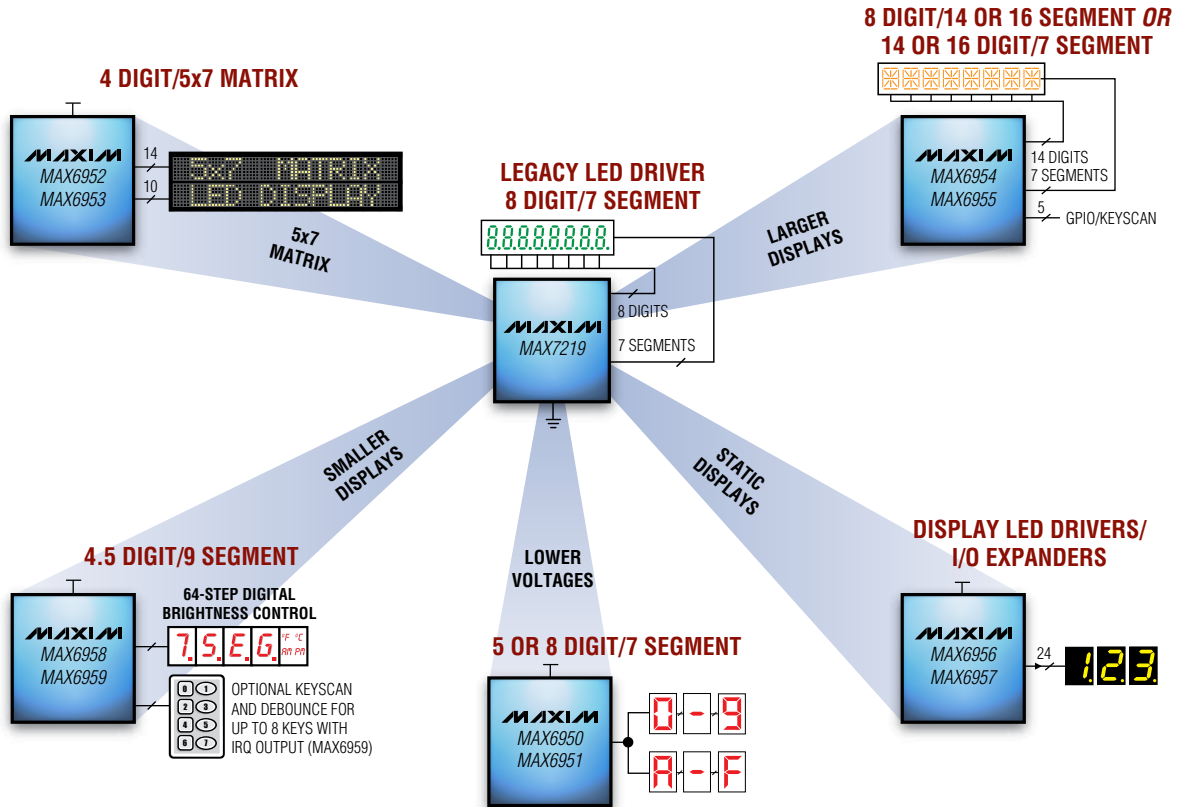

EV kits available

Part	Interface Type (Hz, max)	Supply (V)	Display Type	Total LEDs	Fonts	Applications	Package
MAX6950	26M SPI	2.7 to 5.5	5 digit/7 segment + DP	40	Hex	Panel meters, set-top boxes, white goods, cell phones	16-QSOP
MAX6951	26M SPI	2.7 to 5.5	8 digit/7 segment + DP	64	Hex		
MAX6952/3	26M SPI/400k I ² C	2.7 to 5.5	4 digit/5x7 matrix	140	104 fixed plus 24 user-definable characters	Audio/video, industrial equip, message boards	40-DIP, 36-SSOP
MAX6954/5	26M SPI/400k I ² C	2.7 to 5.5	16 digit/7 segment + DP 8 digit/14 or 16 segment + DP	128	Hex, 104 fixed	Audio/video, set-top boxes, white goods	40-DIP, 36-SSOP
MAX6956/7	26M SPI/400k I ² C	2.7 to 5.5	Static (any type)	20 or 28	—	Automotive, industrial equip, panel meters	28-DIP/SSOP, 40-TQFN, 36-SSOP
MAX6958/9	400k I ² C	3 to 5.5	4.5 digit/9 segment	36/32	Hex	Audio/video, industrial equip, vending machines	16-PDIP/QSOP
MAX7219	10M 4-wire serial	4 to 5.5	8 digit/7 segment + DP	64	Code 8	Panel meters	24-PDIP/SO

www.maxim-ic.com/Displays

27-bit LVDS serializers/deserializers for automotive navigation systems

Programmable spread spectrum, drive up to 1280 x 480 displays

The MAX9247/MAX9248/MAX9250 27-bit, DC-balanced serializers/deserializers (SerDes) feature preemphasis and programmable spread-spectrum capability, which spreads both output data and clock for maximum EMI reduction. These devices are ideal for driving WVGA, VGA, and QVGA displays.

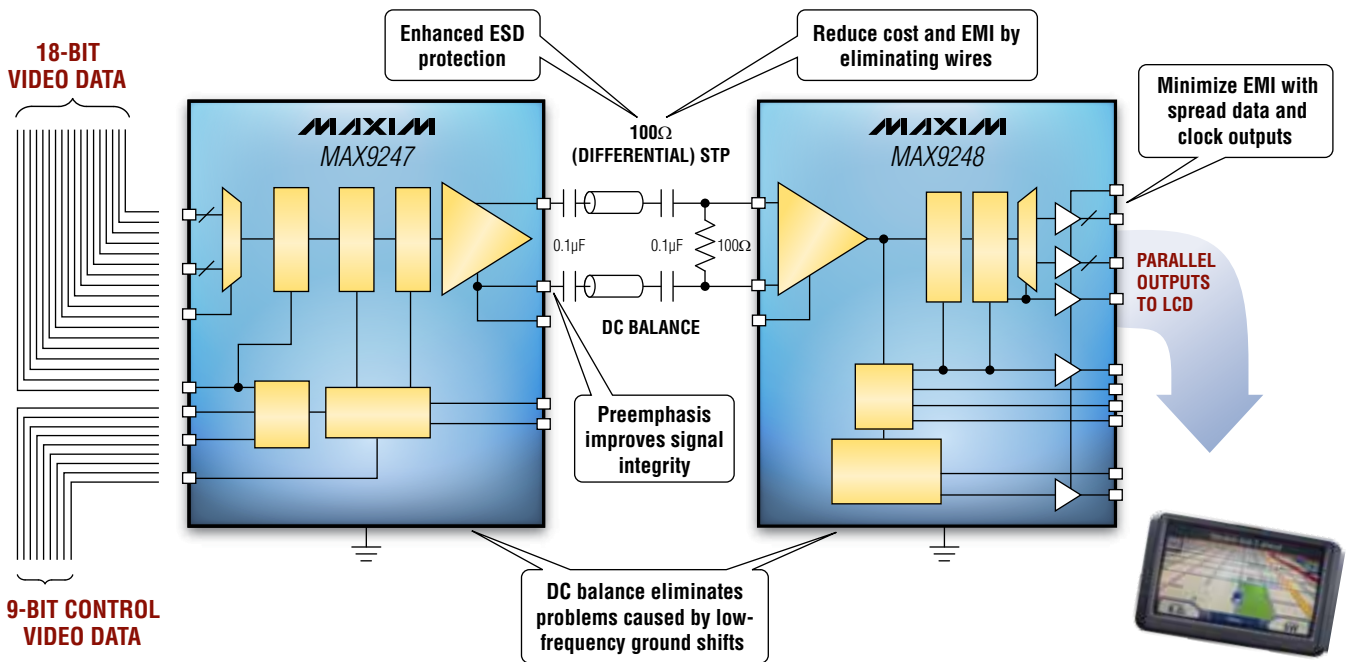

Preemphasis improves eye diagram

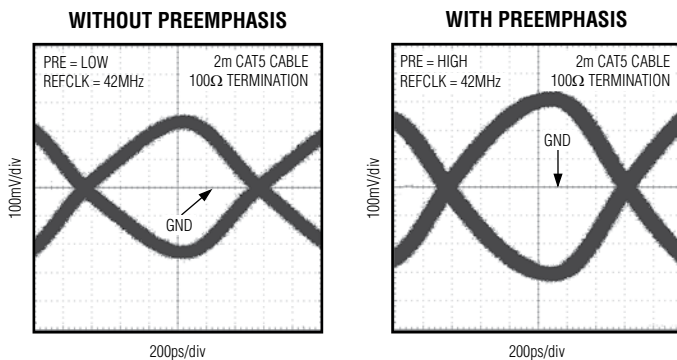

Spread spectrum reduces EMI

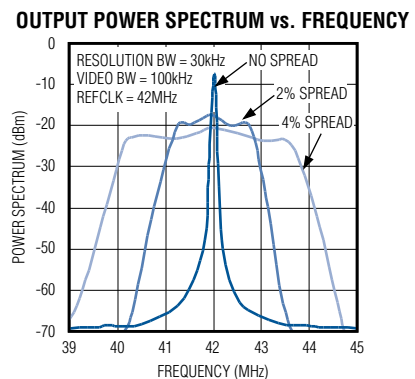

Serializers

Part	Clock (MHz)	Features
MAX9247	2.5 to 42	Output common-mode filter, selectable preemphasis
MAX9217	3 to 35	Output common-mode filter

Deserializers

Part	Clock (MHz)	Features
MAX9248	2.5 to 42	Selectable $\pm 2\%$ or $\pm 4\%$ spread spectrum
MAX9250	2.5 to 42	Output enable
MAX9218	3 to 35	Output enable

Programmable gamma reference generators and VCOM calibrators

Maxim offers a rich portfolio of programmable gamma and VCOM reference systems for LCD display products. These devices feature a wide supply range and high-output-current amplifiers. They are available in TQFN-EP packages that provide excellent heat dissipation from a small footprint, as well as easy assembly and PCB layout.



Without programmable gamma solution

With Maxim's programmable gamma solution

- MTP (multiple-time programming) memory supports 100x rewrite
- High peak current for gamma and VCOM channels
- TQFN-EP package simplifies layout
- I²C-compatible serial interface

Programmable gamma reference generators

Part	Channels	Resolution (Bits)	Integrated NV Memory	Integrated VCOM	Interface	Features
MAX5679	18	8		✓	I ² C	Integrated DVR for setting VCOM
MAX9591	18	8			I ² C	Two banks of volatile memory capable of fast switching
MAX9669	16	10	✓	✓	I ² C	—
MAX9674*	16	10	✓	✓	I ² C	External reference input for gamma DACs
MAX9673*	14	10	✓	✓	I ² C	External reference input for gamma DACs
MAX9672*	12	10	✓	✓	I ² C	External reference input for gamma DACs
MAX9697	12	10			SPI	Integrated LDO
MAX9667	10	10	✓	✓	I ² C, 1-Wire®	—
MAX9666	8	10	✓	✓	I ² C, 1-Wire	—
MAX9665	6	10	✓	✓	I ² C, 1-Wire	—

VCOM calibrators

Part	Channels	Peak Current (mA)	Rail to Rail	BW (MHz)	Slew Rate (V/μs)	Features	Programmable
MAX9550	1	800	Out	See data sheet	See data sheet	Thermal shutdown	—
MAX9551	2	800	Out	See data sheet	See data sheet	Thermal shutdown	—
MAX9552	4	800	Out	See data sheet	See data sheet	Thermal shutdown	—
MAX9650	1	1300	In/out	35	40	Thermal shutdown	—
MAX9651	2	1300	In/out	35	40	Thermal shutdown	—
MAX9660	1	900	Out	20	45	Output current limit, programmable	7-bit I ² C

1-Wire is a registered trademark of Maxim Integrated Products, Inc.
 *Future product—contact the factory for availability.

Digitally programmable LED driver fits a broad range of backlighting applications

I²C interface simplifies design optimization

The MAX16826 integrates a boost/SEPIC converter and four linear current sinks to drive four LED strings. The device is uniquely equipped with an I²C interface that enables designers to independently configure the LED current of each string, program the boost/SEPIC output voltage, and read the voltages of the LEDs through an internal ADC. External MOSFETs allow a wide range of LED current levels and voltages, and improve the thermal design by dissipating power over a larger board area. The MAX16826 thus allows the same driver circuit to be used for multiple applications with only simple changes in either the software or external design.

- Boost/SEPIC converter and linear current sinks
- I²C interface to control LED current and voltage, and read faults
- Independent PWM dimming for each string
- LED short and open protection
- Up to 24V input capability; can withstand 40V load dump
- Switching-frequency synchronization reduces EMI
- Delivers up to 500mA/string
- -40°C to +125°C auto temp range

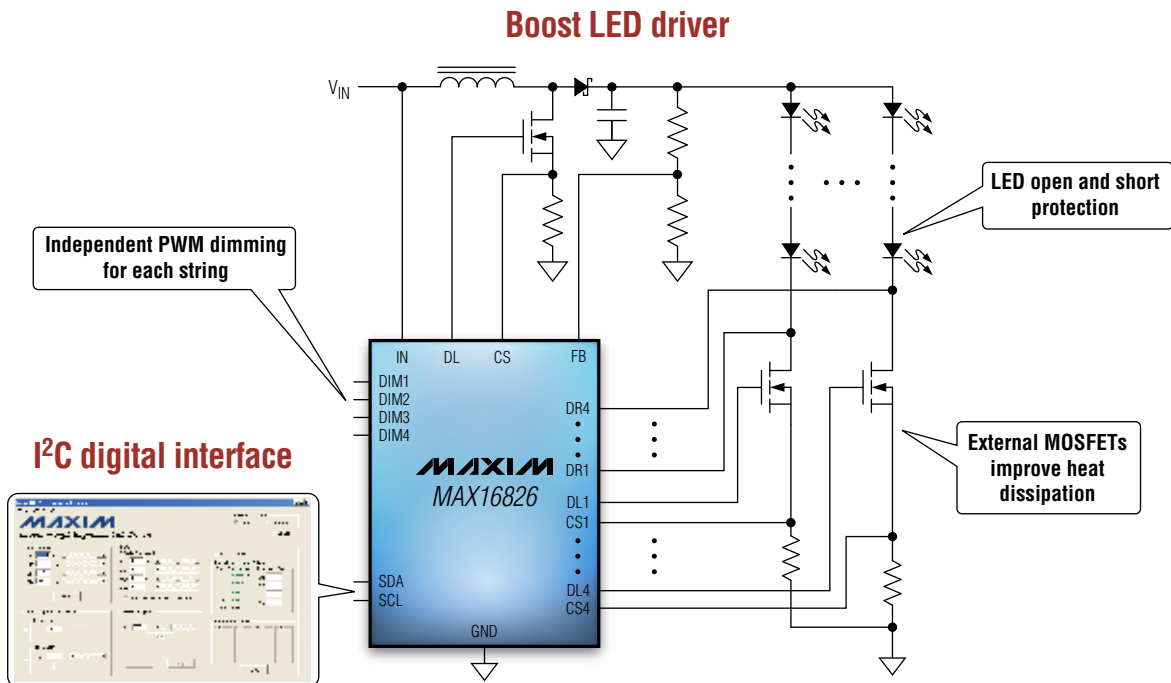

Highly integrated, high-output-current LED drivers reduce backlighting cost

The MAX16814*/MAX16838* are highly integrated LED drivers designed to minimize the cost and complexity of high-current, multistring backlighting designs. These devices integrate a switching converter to provide the supply voltage for all LED strings and linear current sinks. Meanwhile, adaptive voltage optimization automatically adjusts the boost output voltage to the supply voltage needed by the LEDs, thus eliminating the need for external components. The devices' high input-voltage capability, -40°C to +125°C operating range, and switching-frequency synchronization make them well suited for automotive applications.

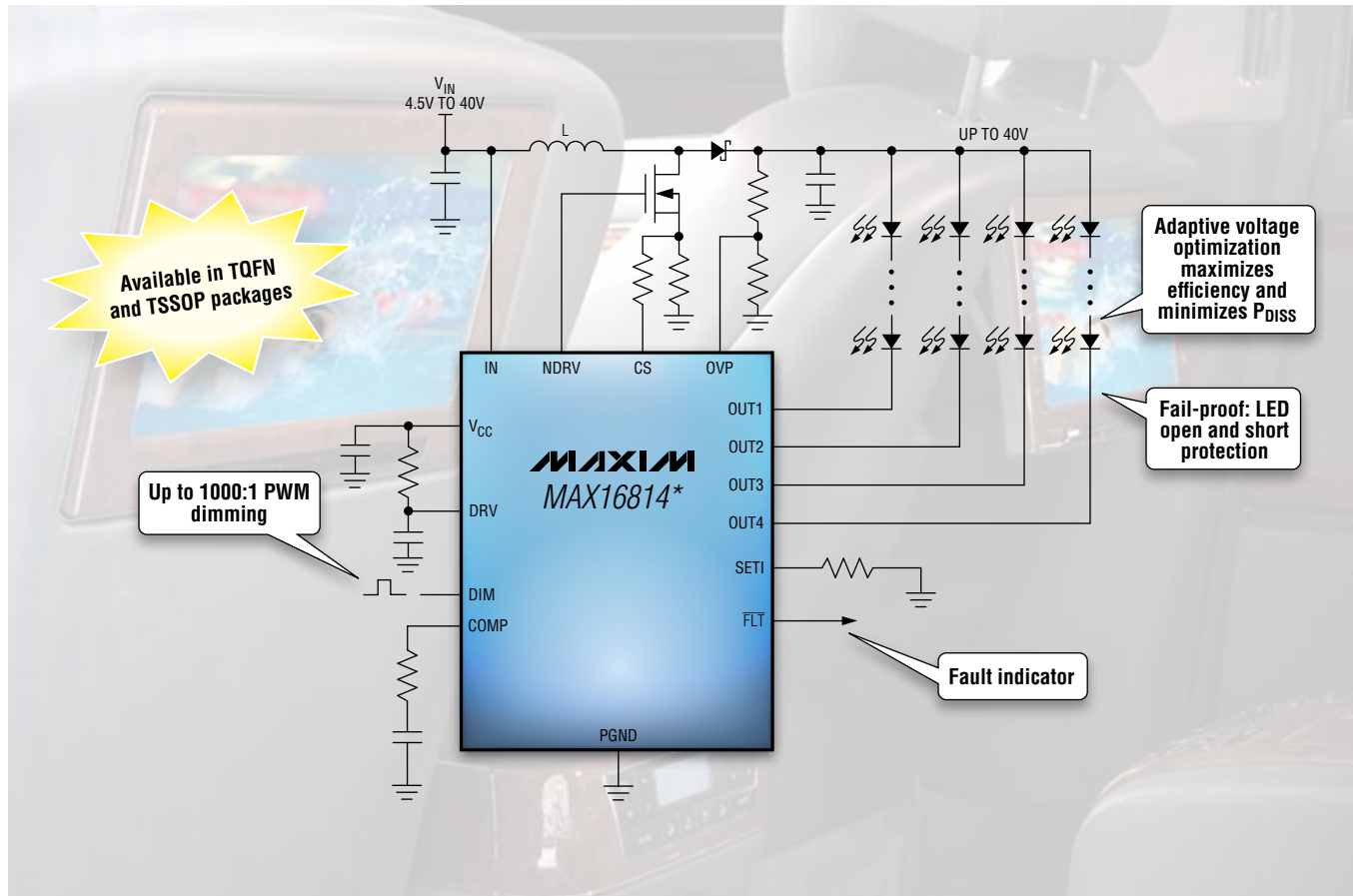

- **MAX16814:** 4-string driver with integrated linear current-sink MOSFETs
- **MAX16838:** 2-string driver with integrated linear and switching MOSFETs
- Deliver up to 150mA/string
- Up to 40V input
- Up to 40V output, higher with external MOSFETs
- 1000:1 PWM dimming range
- Switching-frequency synchronization reduces EMI



- LCD TVs
- Automotive displays
- Desktop displays

*Future product—contact the factory for availability.

Flexible, robust LED driver offers fast PWM dimming

Supports boost, buck-boost, and buck topologies

The MAX16834 is a flexible LED driver that can be used in buck, boost, and buck-boost configurations. It can drive up to 70 LEDs in series, and deliver several amperes of current. Additionally, it can operate from up to 28V with no external clamp, or greater than 28V if used with a low-cost voltage clamp at its supply pin. Along with its wide-ranging configurability, the MAX16834 packs in features such as a wide PWM dimming range, an analog dimming input, and a complete set of protections to simplify your design.

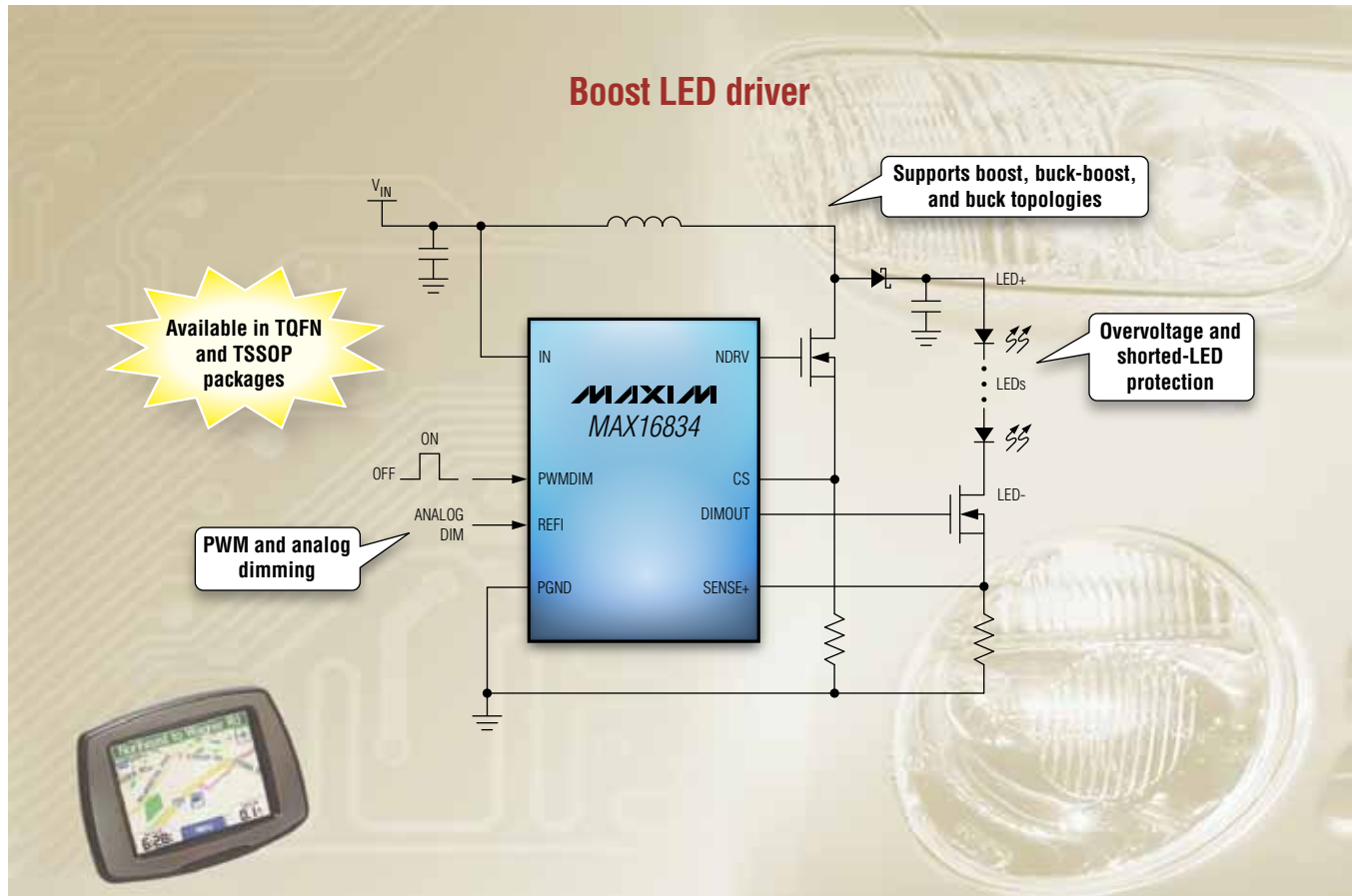

- Can deliver several amperes of LED current
- Up to 28V input, higher with a low-cost external voltage clamp
- Wide 3000:1 PWM dimming range
- Up to 1MHz frequency, externally synchronizable
- Fault output
- -40°C to +125°C automotive temp range



A rich portfolio of high-current linear LED drivers

Maxim's high-current linear LED drivers are designed to reduce the size, cost, and complexity of solid-state lighting (SSL) designs. All of these ICs are specified over the -40°C to +125°C temperature range, provide high LED-current accuracy, support wide input-voltage ranges, and integrate multiple protection features to ensure reliable operation in the most demanding applications.

Our LED drivers offer a variety of advanced features to optimize your design: An internal PWM dimming ramp enables control of the PWM duty cycle with a DC input voltage to simplify your driver circuit; I²C-programmable LED current allows you to compensate for binning variations on the production line; and programmable thermal foldback prevents LED damage by rolling back the current during high temperatures.

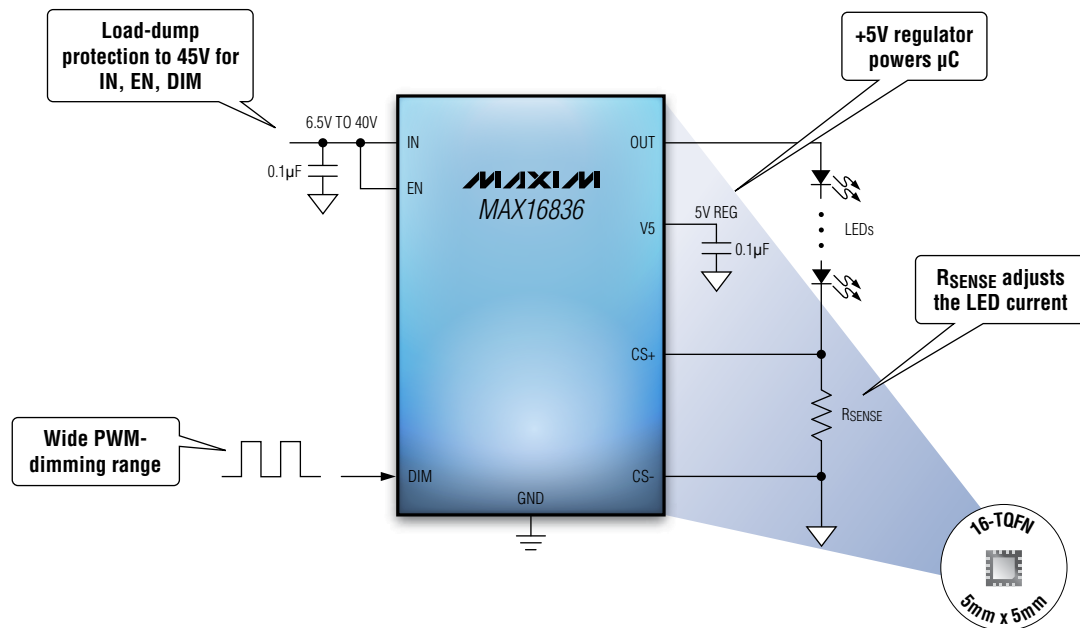

Part	Strings	Input-Voltage Range (V)	Max LED Current (mA/String)	LED Fault Output	Internal PWM-Dimming Ramp	I ² C-Programmable LED Current	I ² C-Programmable Thermal Foldback
MAX16803/36	1	6.5 to 40	350				
MAX16815	1	6.5 to 40	100				
MAX16828	1	6.5 to 40	200				
MAX16804	1	6.5 to 40	350		✓		
MAX16805	1	5.5 to 40	350		✓	✓	
MAX16806	1	5.5 to 40	350		✓	✓	✓
MAX16824/25	3	6.5 to 28	150				
MAX16823	3	5.5 to 40	100	✓			

Yes, we make that...

Maxim has one of the broadest and deepest analog and mixed-signal portfolios, with over 6000 ICs in 28 categories. We average more than one product introduction per day! For over 25 years, we have delivered innovative engineering solutions that add value to our customers' products.

Over 6000 ICs in 28 Product Categories

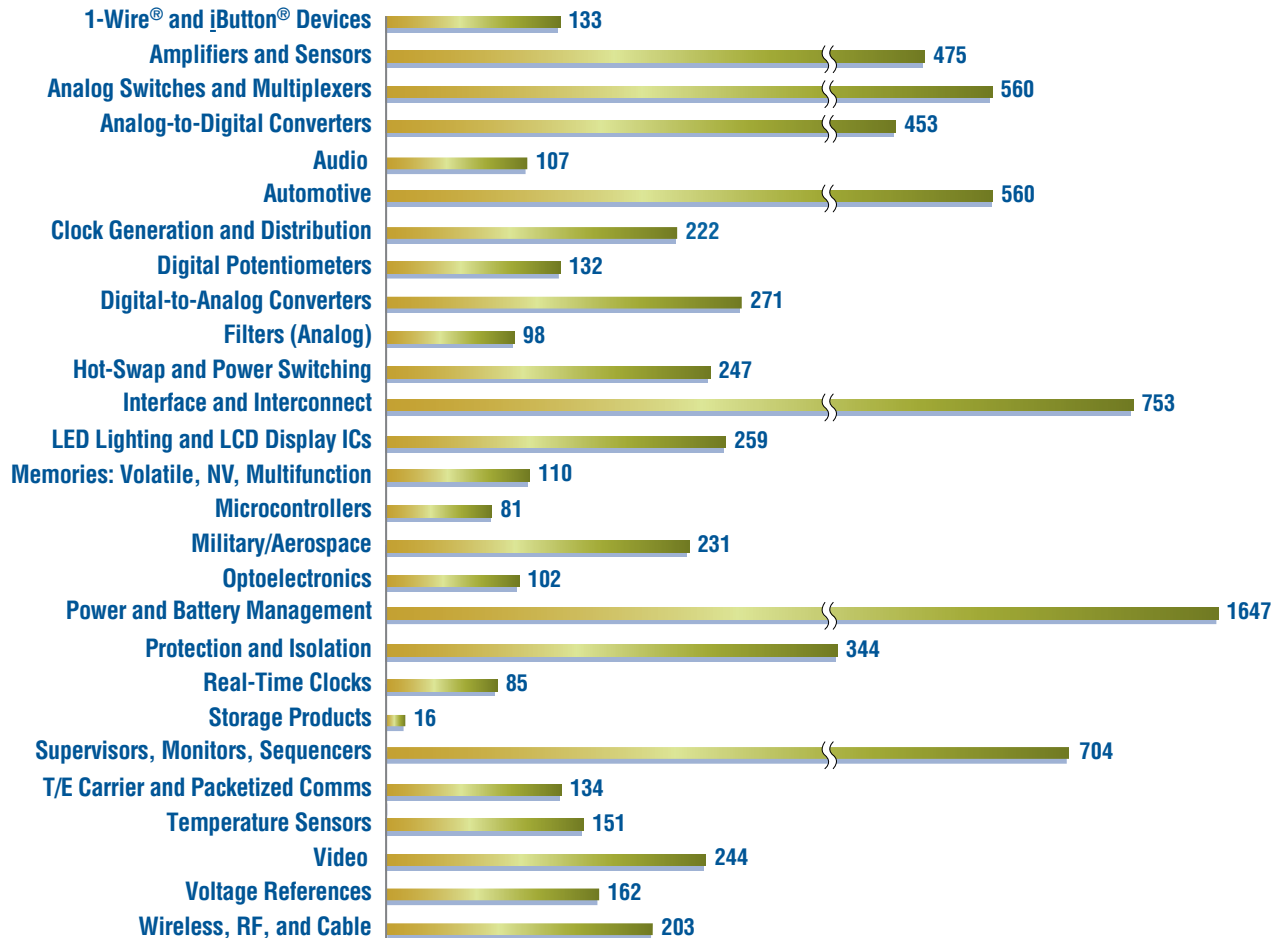

www.maxim-ic.com/yes

Displays-8 US 7/09



www.maxim-ic.com

Maxim Integrated Products, Inc.
120 San Gabriel Drive
Sunnyvale, CA 94086

Appendix: Drawings

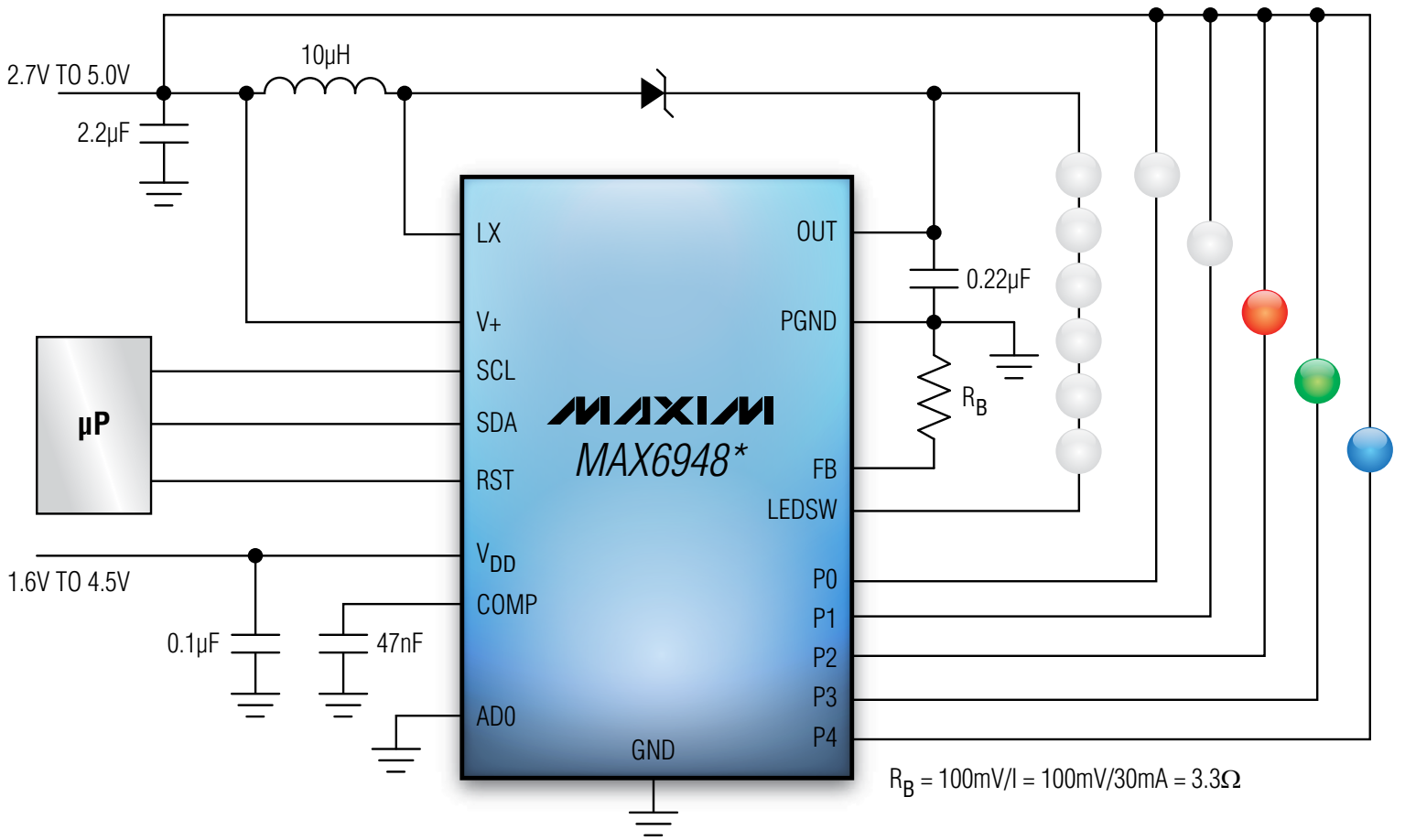

Click anywhere on page to go back



Reduce the number of connections through the hinge

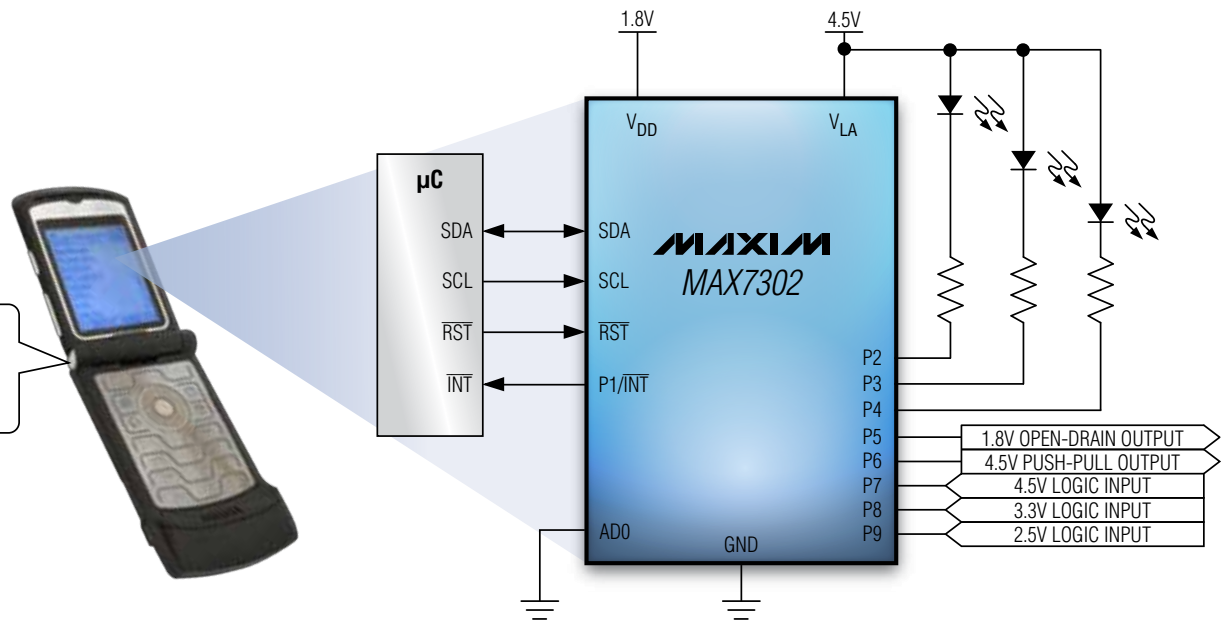

Click anywhere on page to go back



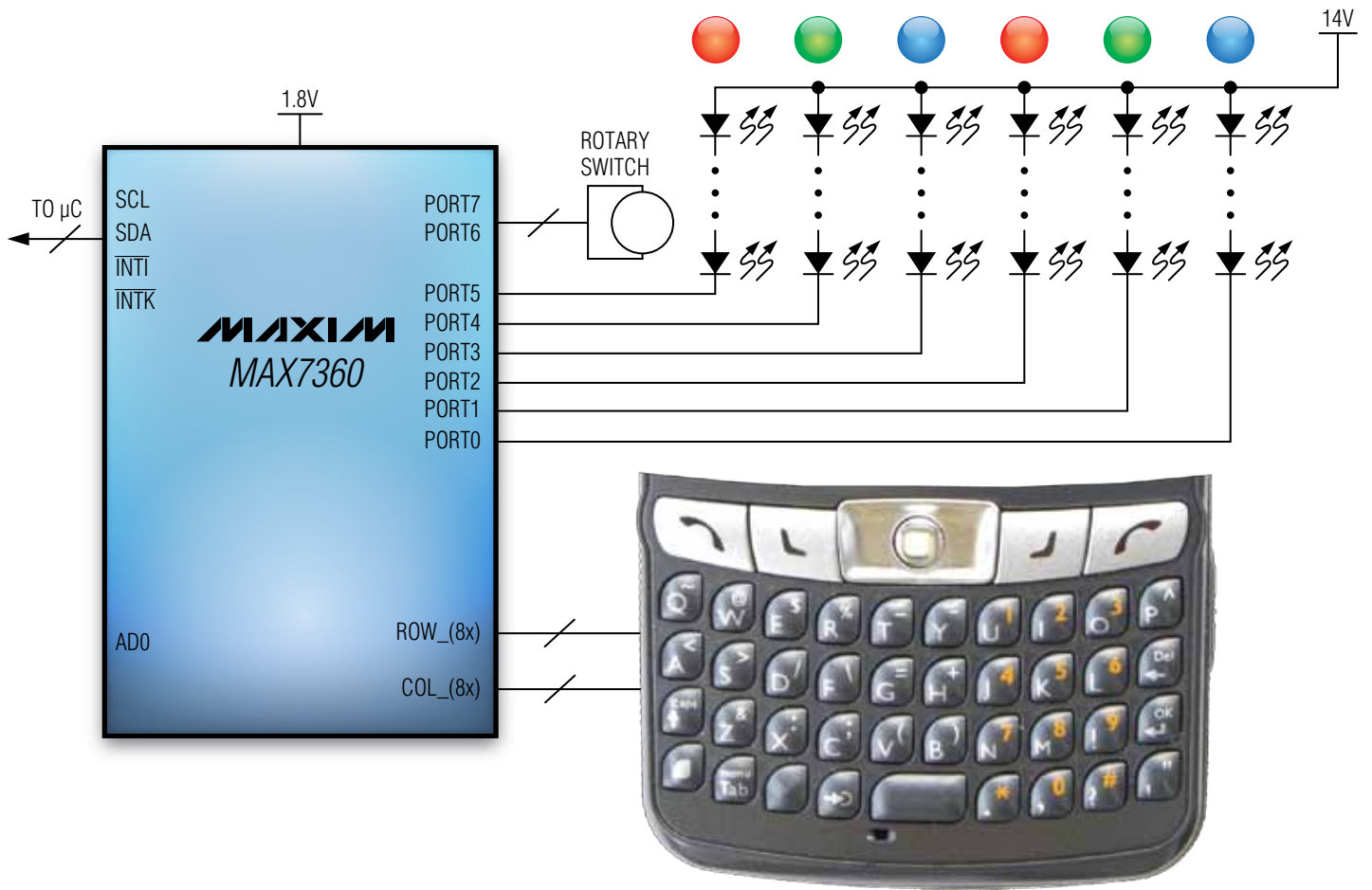

Click anywhere on page to go back



High-speed, 25MHz SPI interface for high data throughput and connection to any μ P

Smart processing reduces interrupt overhead by up to 90%

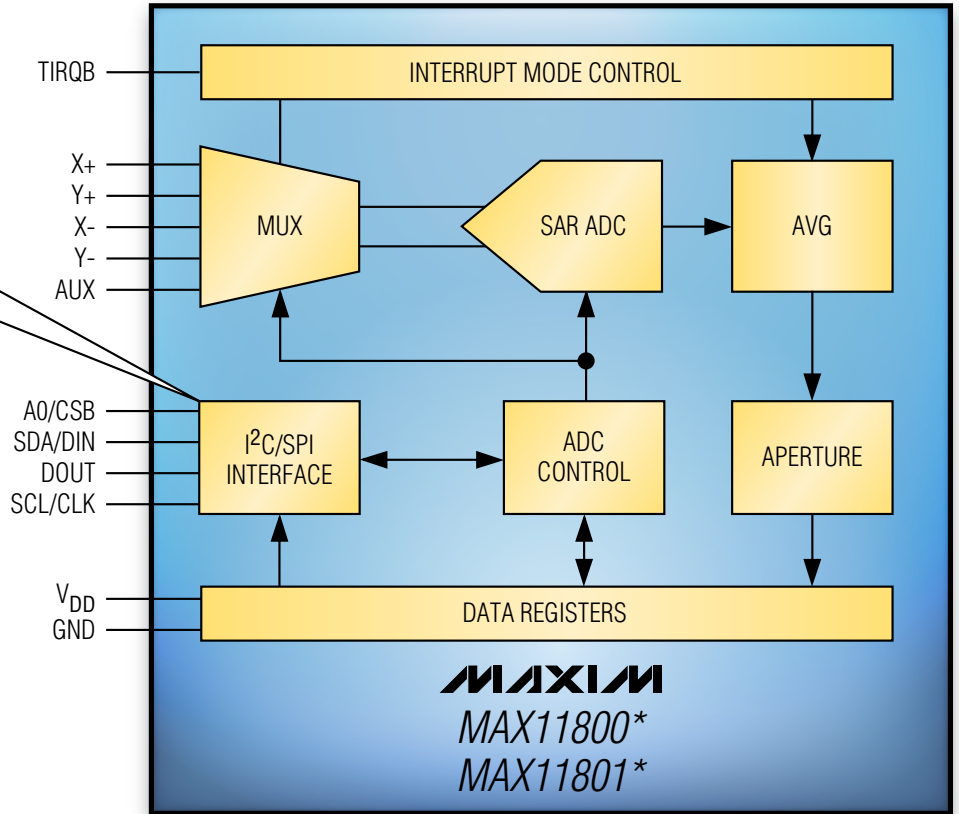

[Click anywhere on page to go back](#)



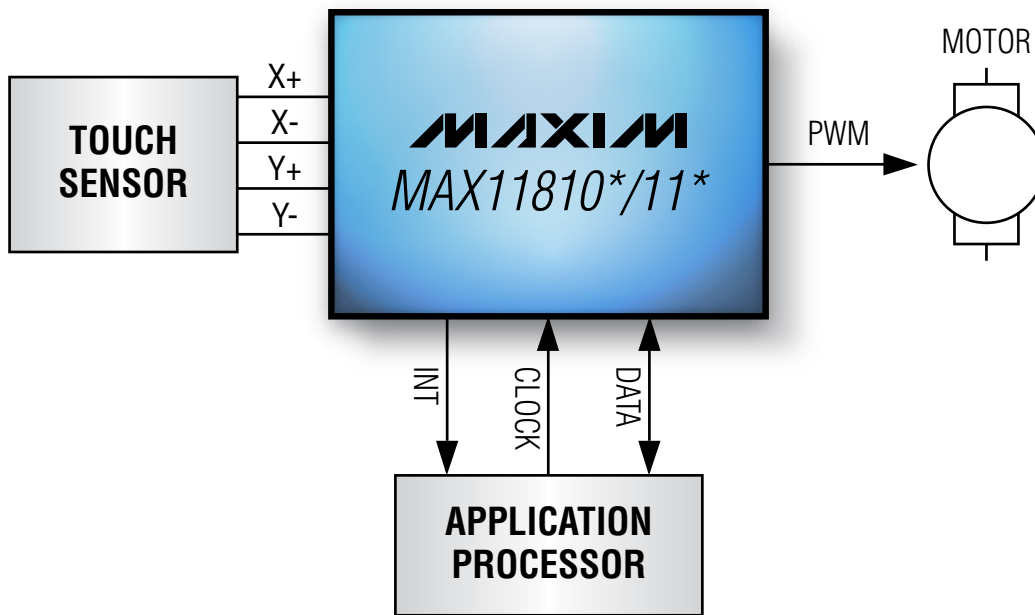

[Click anywhere on page to go back](#)



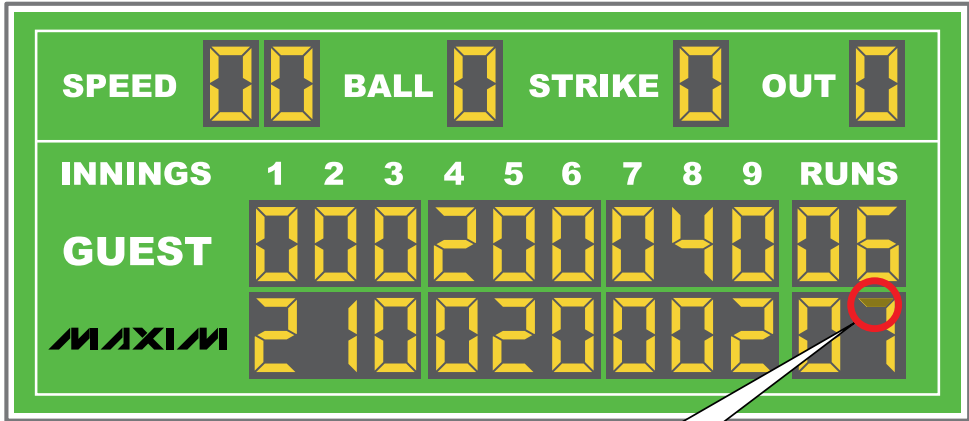

Operate from 3V to 5.5V supply

Open-LED faults—is it 7 or is it 1?

Open-LED faults are indicated in DOUT data stream—ideal for high-accuracy applications

Single resistor sets current for all LEDs

Optional watchdog timer clears display if transmission is interrupted for one second

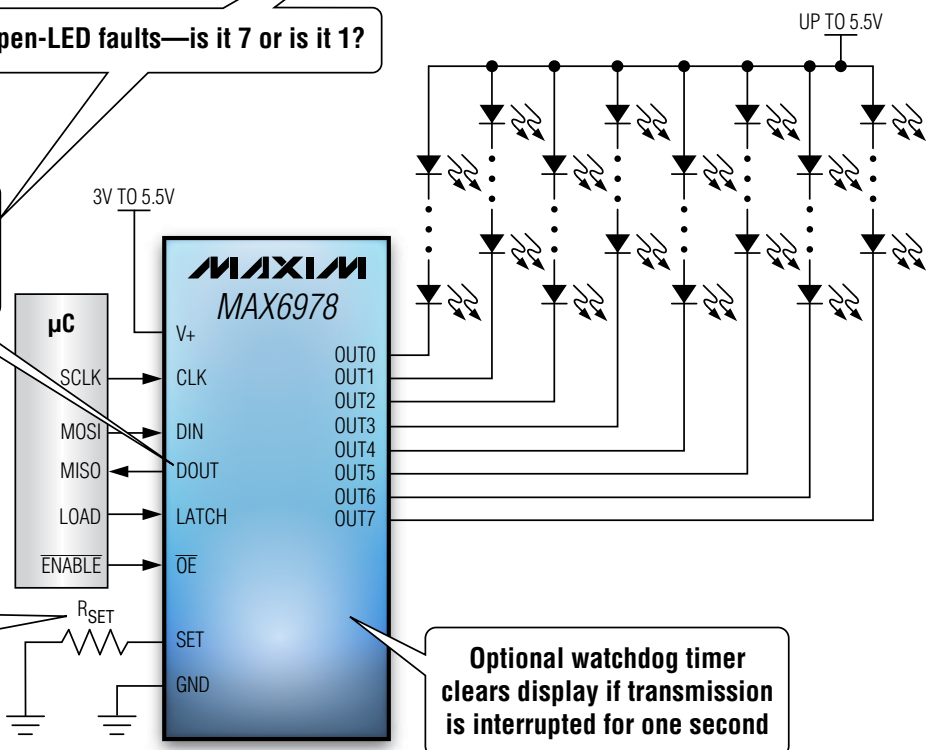

Click anywhere on page to go back



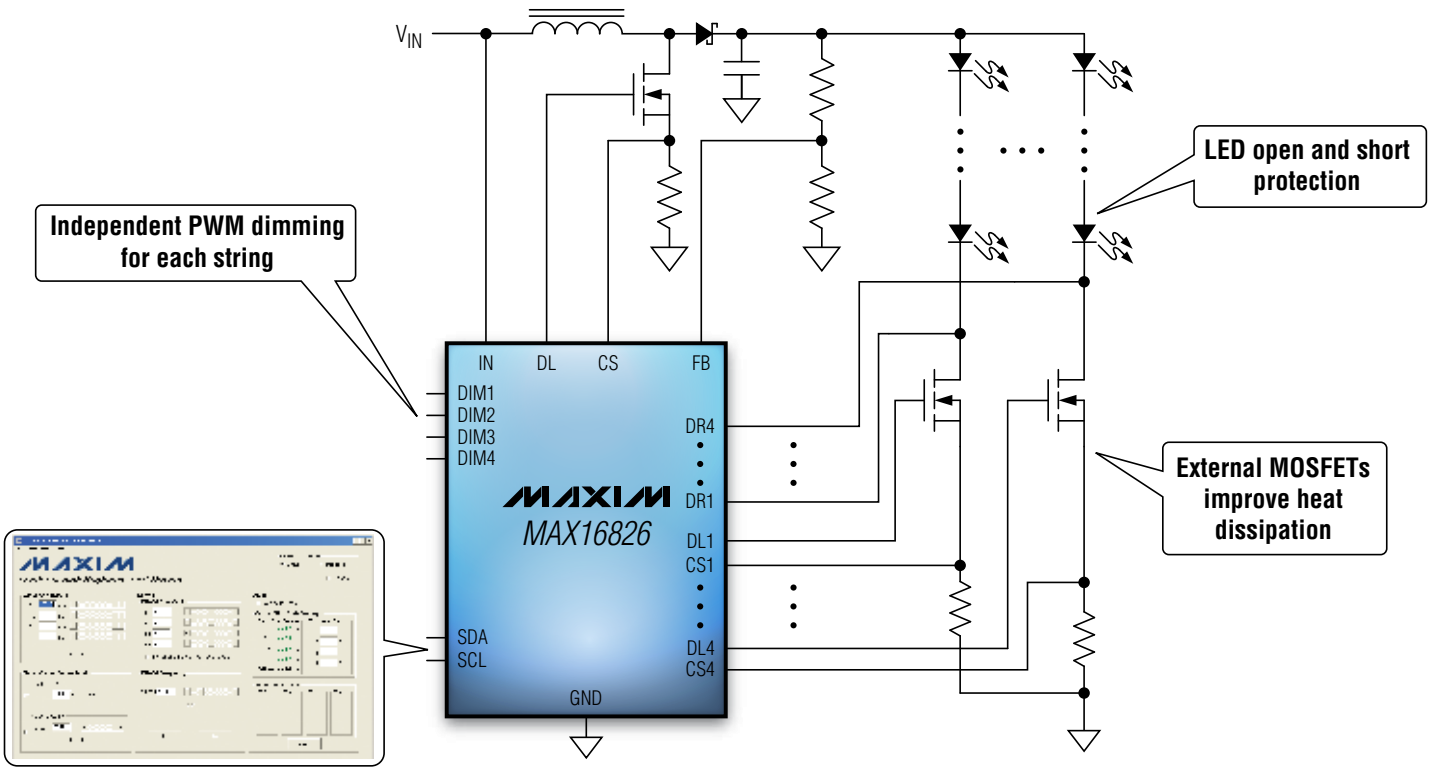

[Click anywhere on page to go back](#)



Available in TQFN and TSSOP packages

Up to 1000:1 PWM dimming

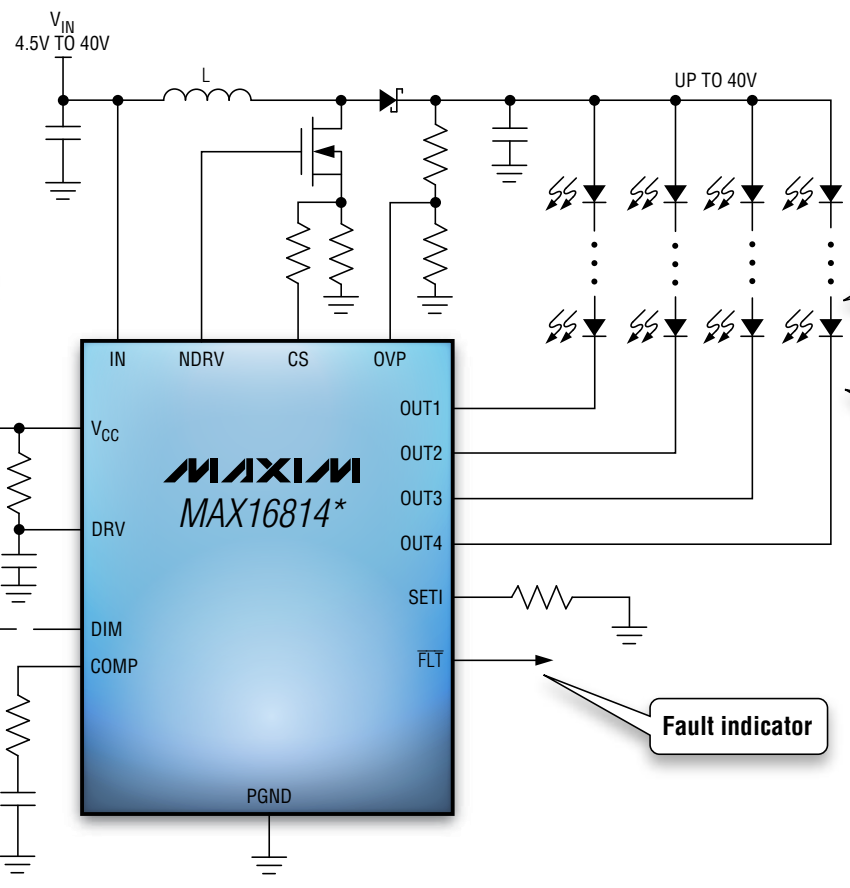

Adaptive voltage optimization maximizes efficiency and minimizes P_{DISS}

Fail-proof: LED open and short protection

Fault indicator

Click anywhere on page to go back



Available in TQFN and TSSOP packages

PWM and analog dimming

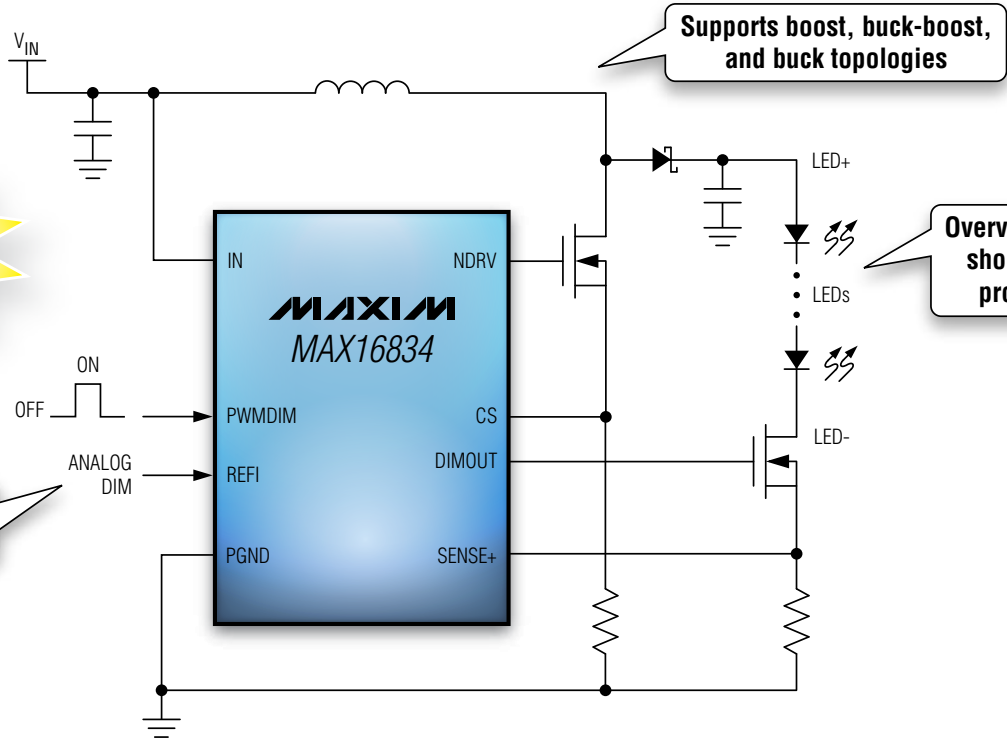

Supports boost, buck-boost, and buck topologies

Overvoltage and shorted-LED protection

Click anywhere on page to go back



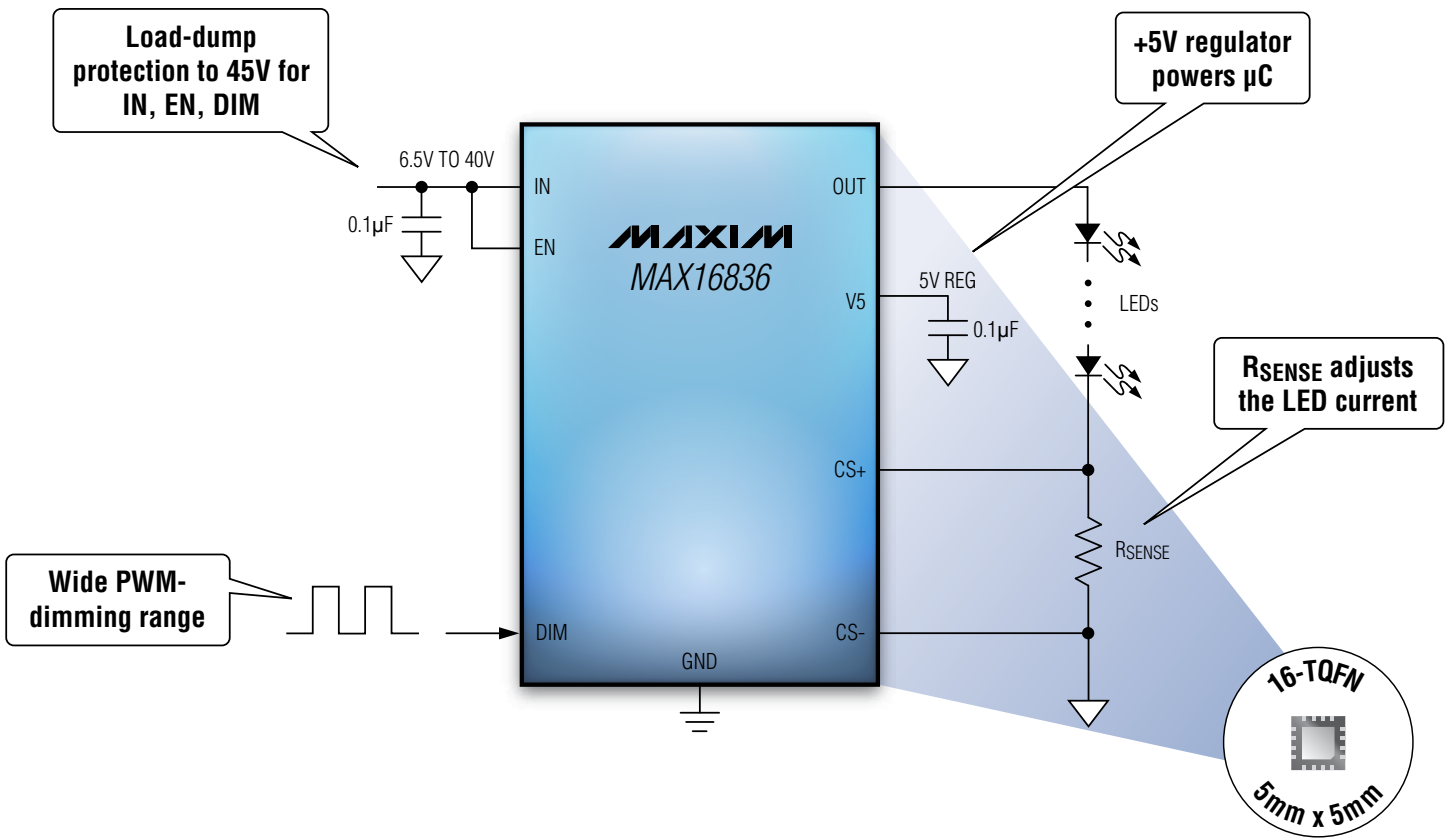

[Click anywhere on page to go back](#)

